

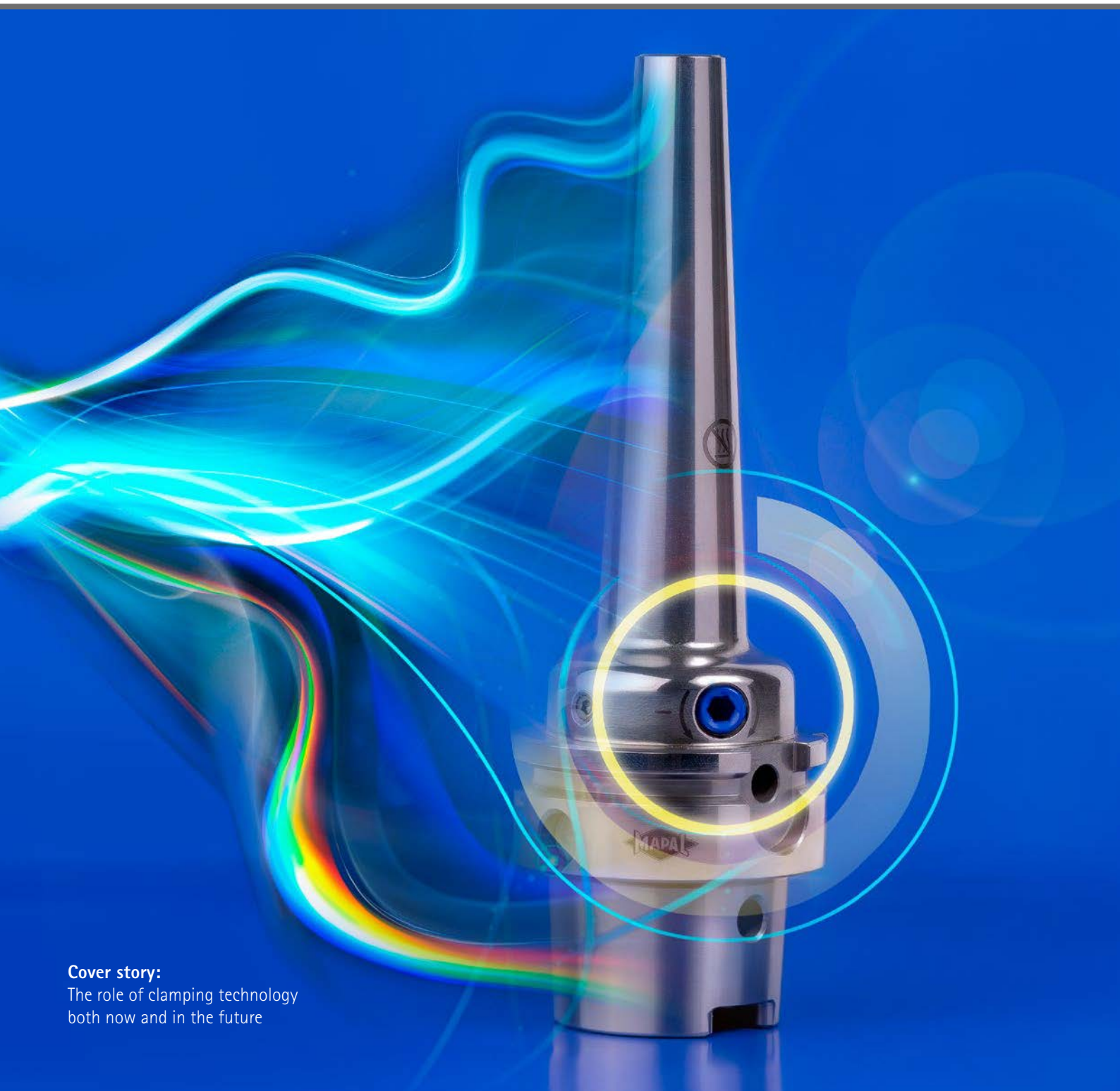

IMPULSE

MAPAL TECHNOLOGY MAGAZINE | EDITION 72



Cover story:
The role of clamping technology
both now and in the future

**Dear readers
and friends of the company,**

I hope that you and your families are doing well. In the face of all the uncertainties caused by the global pandemic, staying healthy remains the number one priority.

Over the past weeks and months, many aspects of our daily lives have changed suddenly and significantly. What's more, we can expect these changes to persist even after the pandemic has passed. The same goes for our relationship with you. Direct communication, close relationships and cooperative partnerships are an important part of the way MAPAL conducts its business.

An important component of that way of working, i.e. our on-site presence, is currently impossible or extremely difficult to implement. While we are increasingly relying on digital communication and video conferencing, these tools can't replace face-to-face contact. That means we now face the challenge of finding new channels and formats that will allow us to remain as close in contact with you as we have ever been.

Of course, the coronavirus pandemic will not last forever. However, it's clear that by the time we reach a "post-corona" season, our routines will have changed quite a bit. Digital communication has increased significantly. The question of what our communications and contact with one another will look like in the future remains to be answered. After so long without any kind of exhibitions taking place, will trade fairs be as important as they have been in the past? Might they even become more important than they were? What will happen to conferences and in-house events? And what will our travel behaviour look like?

We are all asking ourselves these questions (and many more!) at the moment. The situation we are experiencing around the world is completely unprecedented. At MAPAL, we hope that you will join us in taking it step by step back towards normality. I look forward to seeing you again in person.

Best wishes and stay well!

Yours,

Dr Jochen Kress



CONTENTS

FROM THE COMPANY



Particulars
page 11

Taiwan site expanded
pages 12–13

NC theme day in Lindlar:
Programming, simulating, milling
page 37

MAPAL precision tools for the
Netherlands
pages 38–40

Additional representation
in Belgium
page 41

TECHNOLOGY HIGHLIGHTS



14

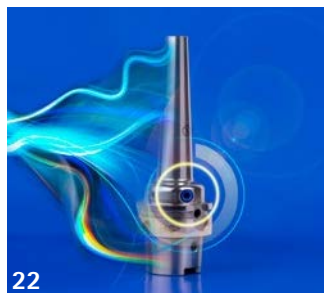

22

PRACTICE REPORTS



6



18



32



42



26

App to detect wear close to market-ready
pages 14–17

Cover story

The role of clamping technology both now and in the future
pages 22–25

Lowering costs with sophisticated tool solutions
pages 32–36

Design prize for MAPAL clamping tools
pages 42–43

A development partnership between a machine manufacturer and a tool manufacturer
pages 6–10

High performance² for the aerospace industry
pages 18–21

Getting vibrations during milling tasks under control
pages 26–29

MAPAL is Part of Project Perseus
pages 30–31

IMPRINT

Editorial team: Andreas Enzenbach (V. i. S. d. P.), Patricia Müller, Oliver Munz, Sabine Raab, Kathrin Rehor, Tobias Zimmermann, Klaus Vollrath
Guest article: Frank Pfeiffer
Layout and Design: Alexander Rückle

Publisher: MAPAL Präzisionswerkzeuge Dr. Kress KG
P.O. Box 1520 | D-73405 Aalen | Phone +49 7361 585-0 | Fax +49 7361 585-1029 | info@mapal.com | www.mapal.com

Print: VVA, Austria | Circulation: 18,000 German, 10,500 English
© MAPAL Präzisionswerkzeuge Dr. Kress KG | Reproduction, even in part, only with the approval of the publisher.

You can subscribe to Impulse under <http://www.mapal.com/en/news/customer-magazine-impulse>

CONCEIVED FROM THE PROCESS

A development partnership
between a machine
manufacturer and a
tool manufacturer

The larger the series of parts to be produced, the more important cycle times and tool costs are. With large quantities, such as those usual for the car industry, the properties of both the machine tool and the tool itself need to be optimally suited to each other – and to the chosen manufacturing process.

"We have a unique approach when we receive customer inquiries," says Meinolf Wolke, Sales Team Leader at ELHA-MASCHINENBAU Liemke KG (ELHA) in Hövelhof. The medium-sized, owner-managed special machine construction company places the workpiece and its machining at the centre of development and devises an optimal solution perfectly designed for the process sequence. "In doing so, we take all the technical and economic requirements into account," clarifies Wolke further. Only then do those responsible decide whether an existing machining concept can be used for the process or whether an individual, application-specific construction is required. Meinolf Wolke explains: "As well as providing the machine, we offer services that stretch from process development and the construction of fixtures all the way through to complete, ready-to-operate solutions with automation and production support."

SPECIAL TOOLS FOR LOW TOTAL COSTS

"The machining tasks are often as unique as the parts themselves – including in terms of the workpiece materials," adds Alexander Wiesner, Technical Advisor at MAPAL. "Of course, a lot of machining work on complex parts can be achieved with standard tools. But that often comes with significant drawbacks in terms of cycle times, quality, and cost-effectiveness, particularly when large quantities are being produced." In these cases, special tools that are precisely calibrated by MAPAL for the machining task in question are preferred.

"During the tool design phase, it's essential to determine the necessary parameters for the machining process," says Wiesner, "particularly in the case of challenging geometries." In order to design the process in the best possible way, MAPAL often makes prototype tools. These are then used to carry out extensive tests with the part to be machined. "That, in turn, helps the equipment manufacturers design the machine with the values identified during testing," continues Wiesner. He says that MAPAL has had a long-standing partnership with ELHA in this area. The following three examples demonstrate the resulting benefits to customers: →



Carina Becker (left) and Jörg Rodehuts Kors (centre) in conversation with Alexander Wiesner in front of an FM3+Xhd production module.

A peek inside the interior of a production module reveals that it features two spindle revolvers (left) as well as two quadruple spindle rows overhead.

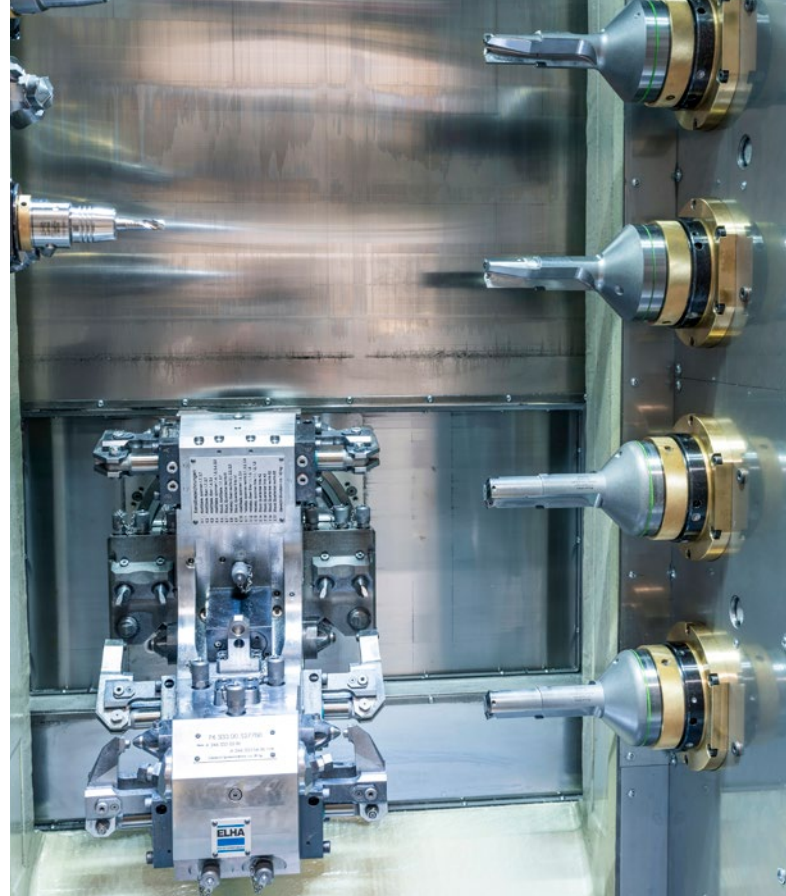

Arrangement of four step drills on the right-hand side of the working area of a production module (Photo provided by ELHA)

SOLID DRILLS for the machining of suspension arms

"We were dissatisfied with the solution that we had been using for drilling from solid in aluminium when machining a suspension arm, which included creating a fitting," remembers ELHA Project Leader Friedhelm Dresmann. At the time, the company was using tools with brazed PCD cutting edges. In order to keep the machining time as low as possible, these drills were being used with very high feed rates. The disadvantages of this solution were the high drive power required and the insufficient durability of the PCD cutting edges on the solid drill step. In search of a solution, those responsible at ELHA turned to MAPAL. Together, the employees of the machine manufacturer and the tool manufacturer worked to find a solution. What they came up with was a hybrid tool. The tip of the tool is equipped with three-bladed, CVD-diamond coated, ISO-indexable inserts for drilling from solid. The fitting is created using brazed PCD cutting edges on the second step of the tool.

MAPAL's research engineers tested the new tool in their own R&D centre. The results were impressive. In addition to the lower costs of the indexable inserts overall, the positive blade geometry meant that less drive power was required. What's more, the previous solution had often produced long metal chips – with the new tool, this was no longer an issue. The indexable inserts at the tip of the drill, which are under significant stress, can be quickly and easily flipped or replaced. As a result, the maintenance costs were also noticeably reduced. Altogether, the suspension arm manufacturers' production costs for each drilled bore were reduced by over 50 percent.



Quadruple application of disc milling cutters on control arms. The solid cutting surfaces provide an indication of the high drive power required (Photo provided by ELHA)

DISC MILLING CUTTERS for the machining of suspension arms

"We also worked with MAPAL to find an efficient solution for machining forged suspension arms," explains ELHA Project Leader Marcel Thieschneider. "Our goal was to develop process-reliable tools while maintaining the required cycle times." For the suspension arm, a yoke needed to be created from the solid material at the end of the arm. During the required four-spindle machining process, the long-chipping workpiece material demands very high drive power to the machine. In addition to this, the internal contour of the part features a number of angles and radii, making the expulsion of chips during milling difficult.

"In order to ensure short process times, we developed a disc milling cutter with ISO indexable inserts that enables roughing and finishing with minimum quantity lubrication in just one step," recalls Alexander Wiesner. The indexable inserts are coated with CVD diamond. The precisely defined arrangement of the individual inserts limits the drive power required. After considering the comprehensive tests at MAPAL and the data that resulted from them, ELHA set its machine to operate at this drive power. A positive side effect of using the disc milling cutter was the reduction in cycle time, as only one cut is needed. On top of that, the tool only occupies one row of spindles, reducing the resulting tool costs for the end customer.

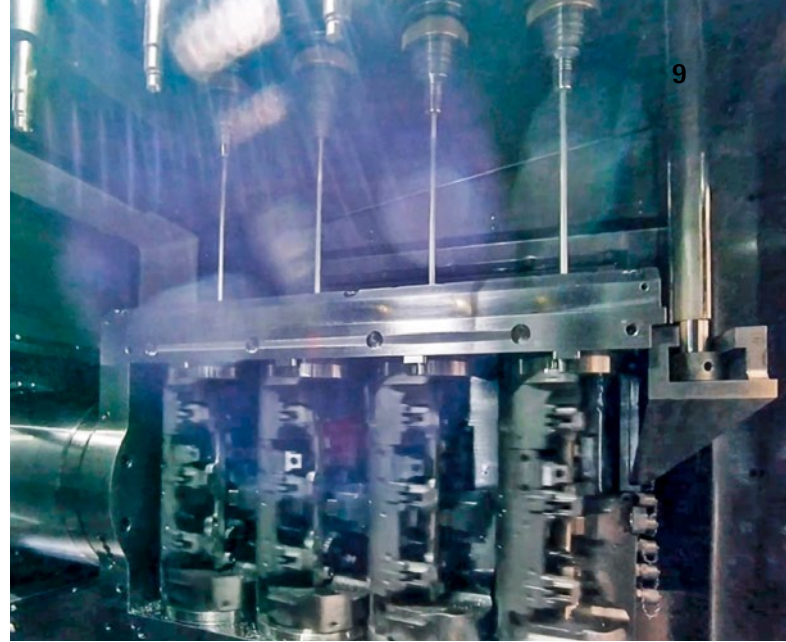

Quadruple machining of fuel-supply distributor parts with deep hole drills. The clamping fixtures that rotate in opposite directions to minimise the deviation of the drill are what makes the solution exceptional (Photo provided by ELHA)

DEEP HOLE DRILL for the machining of stainless steel forged components

"Our customer is a manufacturer of high-pressure fuel-supply distributors for petrol engines. This requires drilling deep bores in narrow, forged, stainless steel blanks," says ELHA Project Leader Jörg Rodehutsors. The material is difficult to machine, and the bore is 300 mm deep. The drill needs to experience as little axial deviation as possible, otherwise wall of the part (which experiences high pressure) will fall below the required minimum thickness. Previously, the manufacturer machined these bores in a separate, single-spindle machine tool with a single-flute deep hole drill.

In order to optimise their processes, the customer asked ELHA to provide a solution in which the process described above, along with all other machining tasks, could be performed on a single production module using multiple spindles. The parts should leave the production module in ready-to-install condition.

ELHA enlisted MAPAL to assist with the bore process previously discussed. The tool manufacturer was asked to provide a drill that was able to carry out the machining more quickly – and with less deviation and less wear and tear. The MAPAL engineers developed a double-edged solid carbide drill designed to meet the requirements perfectly. With application parameters of $V_c = 90 \text{ m/min}$ and $f = 0.5 \text{ mm}$, the new tool achieves a tool life of 80 metres – almost three times as long as the solution previously in use. Another special feature of the solution developed jointly by ELHA and MAPAL is that the workpieces in the clamping fixture rotate in the opposite direction to the drill during machining, which reduces the deviation of the bore even further. This leads to significant cycle time benefits for the customer, who manufactures up to five million of these parts every year. And on top of that, they now only need one machine to carry out all machining tasks. →

THE PRODUCTION MODULE (FM) PHILOSOPHY

ELHA primarily developed the production module series for the cutting manufacturing of mass-produced parts (> 100,000 identical or similar parts). In this manufacturing concept, the tools themselves are not moved, but instead the parts are passed along tools arranged in rows. Every row of tools has a clamp and drive system that is optimised for the machining task. The workpieces are moved from each tool row to the next using the clamping fixture, which achieves the shortest possible chip-to-chip times. The modular system can be equipped with various multi-spindle modules. Multi-spindle revolvers providing space for up to 128 directly driven tools can be used for even more flexibility.

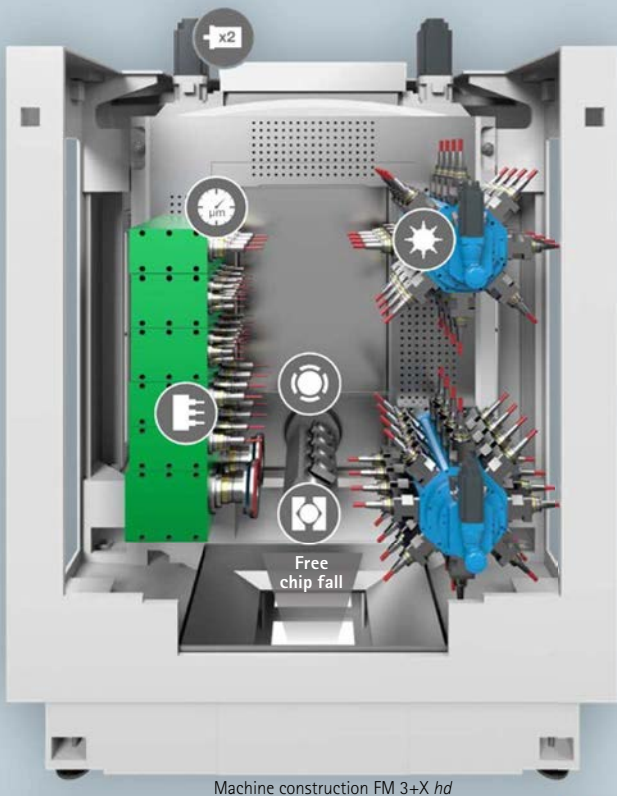

Schematic representation of a production module (Image provided by ELHA)

About ELHA-MASCHINENBAU Liemke KG

ELHA-MASCHINENBAU is a family-run business that manufactures machine tools for cutting metal machining. The company was founded in 1930 and today is known for its machining centres, special-purpose machines and production modules.

DEVELOPMENT PARTNERSHIP SYNERGIES

"These three examples demonstrate the benefits of our close collaboration with MAPAL," concludes Carina Becker from Technical Sales at ELHA. "And on top of that, the cooperation gives our design engineers additional freedom." MAPAL's specialists for the development of high-performance tools, as well as their exceptionally well-equipped R&D department in Aalen, make it possible to develop and intensively test new tool solutions even during the planning phase. That means ELHA is able to offer its customers even more well-engineered and economically advantageous solutions. ■

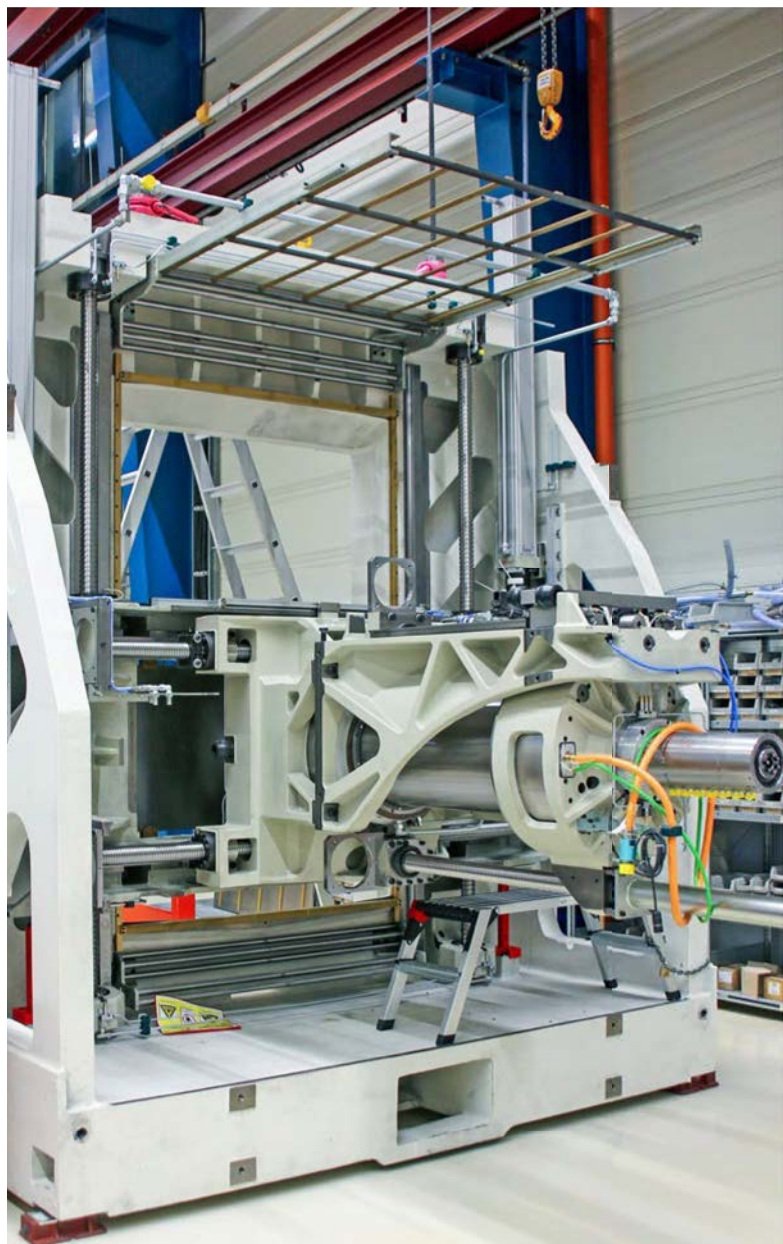

The massive hydrostatically guided working unit at the rear of the machine supplies the 4 or 5 axis transfer of the component which is mounted on a pallet complete with the relevant clamping fixture from spindle row to spindle row.



ROGER STEINER

Managing Director | WEISSKOPF Meiningen

Since November 2019, Roger Steiner has been responsible for the Production and Technology division at WEISSKOPF as Technical Director. Steiner brings relevant experience from his previous activities in this field to the table. Uwe Rein, who has led activities in Meiningen since 2015, will remain responsible for distribution and commercial operations.

PARTICULARS

JACEK KRUSZYNSKI

Senior Vice President Product Management and Market Segments | MAPAL Aalen

MAPAL's expanded executive board gained a new member in January. As Senior Vice President, Jacek Kruszynski is responsible for the Product Management division as well as the Die & Mould, Aerospace and E-Mobility sector. The mechanical engineer brings extensive experience with him to MAPAL. Kruszynski has spent his entire working life to date in leadership positions in the tool sector. Among other things, he has acted as a development lead and managing director.



CARSTEN LEHMANN

Managing Director | Centre of Competence PCD Tools, Pforzheim

The Centre of Competence PCD Tools in Pforzheim has a new Director for Distribution, Product Management and Development. Carsten Lehman took over the position in April. He is the successor to Alexander Raach, who is pursuing a new professional challenge. Lehman has been working in a leadership position in the tool sector for many years and possesses excellent knowledge of the market and products.



Taiwan site expanded

MAPAL PTS in Taiwan has extended its capacities at the Tainan site. The company has put a second production hall into operation. The construction of the two-storey building with approximately 1,600 square metres of floor space took approximately one year.

"It's the right move to enable us to meet the increasing demand," says Antonio Kao, CEO of MAPAL PTS, explaining the building project. The quantity of orders received by the company has steadily increased over the past years. "In 2017, we reached the limits of our production capacities," reports Kao. There was no question that management would find a way to provide additional production resources; MAPAL PTS wanted to be a reliable partner to its customers. It's the second large-scale expansion of the factory, founded in 2001, which currently employs 111 workers. A manufacturing facility for PCD tools was built in 2010. In addition to PCD tools, the employees at the site also produce tools with ISO elements and fine boring tools. All MAPAL PTS products are manufactured in accordance with the high international standards of the MAPAL

group. The plant in Taiwan supplies customers in Taiwan and its neighbouring countries. MAPAL PTS is part of the MAPAL group's global network and works closely with the MAPAL distribution organisations in China, Japan, Thailand, Indonesia, Australia, Malaysia, and South Korea.

The second production hall provides MAPAL PTS with 30 percent more capacity, which the company uses primarily for the manufacturing of PCD tools. In addition to this, the leadership has expanded the measurement, testing, and logistics areas and further optimised the manufacturing processes. The investment in the factory totalled approximately 1.7 million euros, of which 940,000 were spent on machines and equipment. ■



*Enjoyment from the management team of MAPAL PTS:
The company opened a second production hall in Tainan.*



Tainan, Taiwan

Picture source: iStock (fototrav)



Extremely up-to-date manufacturing conditions ensure the highest standards of quality. The production capabilities for PCD tools have now been significantly expanded.



Customer satisfaction is the top priority for the entire team.

瑪帕精密刀具系統(股)公司 新廠落成啓用

App to detect wear close to market-ready

» THE DIGITAL POTENTIAL IS

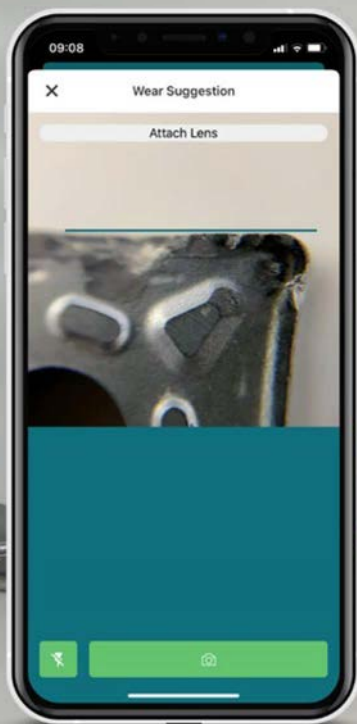

c-Com is adding another function to the many features of its existing apps: technical advice for machinists.

Giari Fiorucci

Picture source: Frank Pfeiffer

ENORMOUS«

At EMO 2019, software service provider c-Com presented yet another aspect of its eponymous open-cloud tool management platform: an app based on machine learning that enables users to detect tool wear using a smartphone. The prototype is currently being developed for market release. In an interview, c-Com's Managing Director Giari Fiorucci and Dr Sven Winkelmann, Research Specialist for Machine Learning at c-Com, explain what led to the development of the app, what it can do, and what features machine operators can expect.

Interview by Frank Pfeiffer

Frank Pfeiffer: *Mr. Fiorucci, what feedback about the new wear detection app for smartphones have you received since it was revealed at the EMO?*

Giari Fiorucci: The app has already become a topic of conversation in the sector. Even at the EMO, the high level of interest exceeded our expectations. Although we consciously labelled the app as a prototype, many machine operators seem to have immediately recognised its potential for use in practice. You could argue that new features for mobile end devices always spark users' curiosity. But we are particularly pleased that participants in our very practicality-oriented sector registered their interest at the trade fair. For us, digitalisation for Industry 4.0 isn't just a modern catchphrase that which hardly affects us in practice – it's a development that affects us and provides us with added value.

What was the motivation for this development?

Dr Sven Winkelmann: Every cutting task involves a level of wear on the cutting edge – you could say it's every machinist's constant, unwanted guest. This affects the manufacturing process and reduces the achievable quality of the parts. If the wear appears suddenly or is more pronounced than anticipated, it can bring an entire stage of production to a standstill. Up until now, that kind of occurrence (in which the tool life ends as a result of cutting edge failure) sets into movement a chain of events: the user needs to remove the tool from the machine and show it to the relevant tool consultant, who then has it inspected by the manufacturer. All of that involves multiple communication loops. We were convinced that this effort could be minimised and that the task could be resolved using the opportunities provided by artificial intelligence. The goal we had in mind was quick analysis of the wear on site, quick error resolution, and quick resumption of production with optimised parameters. And thanks to the app, that goal is now achievable.

What are the tangible benefits for the user?

Fiorucci: By using the app, a machinist can identify and evaluate the wear on the cutting edge in the shortest time possible. All they need is a smartphone with a commercially available magnification lens. After the lens has been mounted on the device, the machinist takes a photograph of the worn insert. The app then identifies the kind of wear in question and recommends measures for avoiding this kind of wear in the future. The app is able to recognise different kinds of wear, such as clearance surface wear, crater wear, and the development of built-up on the cutting edges, and can advise operators, for example, to reduce the feed rate, increase the spindle speed, or change the cutting material or its coating.

How is the app able to do that?

Dr Winkelmann: Thanks to machine learning technology – a method that can be summarised as the synthetic generation of knowledge based on experience. In other words, the IT system learns from practical examples in the form of evaluated information, and is able to universalise and apply that information after a certain learning period. And we already have access to a wealth of experience (in this case on cutting edges and the way they experience wear in practical applications) through our development partner MAPAL. →

Fiorucci: MAPAL already acknowledges the importance of insert wear by providing information on best practices for tool use with wear diagrams and advice on maximising tool life in its catalogues. However, fewer and fewer users are tool specialists who are able to interpret these instructions correctly. With the app, even less-experienced users become experts, as the algorithm we have trained gives them access to an objective means of assessment. And, incidentally, it can be used for indexable inserts from all manufacturers.

So taking a picture of the insert is the first step?

Dr Winkelmann: Exactly. Our starting point for development was the ability to use a smartphone to take a picture of the cutting edge of an indexable insert with a clarity level that could previously only be achieved with a microscope under laboratory conditions. Nowadays, this kind of picture can be taken by modern end devices thanks to their resolution, processing

power and connectivity. Of course, we had to carry out comprehensive tests in which we took pictures under all manufacturing conditions imaginable. In the end, we were able to develop a practical solution. There's no longer a need for a device with a static design: our users have everything they need in their pocket. And that also means they always have their technical advisor with them.

What turned out to be the biggest challenge?

Dr Winkelmann: Creating a suitable learning database. Even the best learning algorithm won't work if it doesn't have enough reliable information. When we realised this, we chose the clearest examples from several thousand images of real wear tests, labelled and categorised each one with the type of wear in question, and trained our model using this database. In this system, which is also called Deep Learning, the neural net trained using the data doesn't operate based on "if/then" rules but instead



Dr Sven Winkelmann
Picture source: Frank Pfeiffer

on the basis of learning models. You tell the system what specific image characteristics mean, and then it stores that information and learns to recognise the characteristics in different images.

What impact does this system have on wear?

Fiorucci: Unfortunately, the app can't prevent wear – but with the help of the app, wear only occurs at the minimum level possible under the specific circumstances of use. And the operator no longer needs to replace the insert based on appearance or on a hunch, but can do so on the basis of specific, reliable parameters. In the event of an accident, for example as the result of a macroscopic flaw in the cutting edge, the cause can be quickly determined and the operator can avoid it happening again. On top of that, it becomes easier to implement time-based specifications that increase efficiency, as operators can plan for an increase in tool life and process optimisations.

Was the app already part of the concept when c-Com was first presented in 2016?

Fiorucci: Yes, we already had the idea of it as an element. We wanted to find a way of applying the potential of machine learning in c-Com. Dr Jochen Kress, who is President of the MAPAL Group and a source of great inspiration for c-Com, planned for that right from the start. But it wasn't until a year ago that we at c-Com saw that the time was right to make the dream a reality. One thing that came out of it was that Dr Winkelmann, who has a good understanding of the machine-learning field, joining our team.

What's next for the app project?

We will now be applying the expertise we have developed with regard to indexable inserts to other tool types. That should make the app even more interesting for users. The next step is to make the app capable of providing even more detailed advice on minimising wear.

Fiorucci: The next stage of development should be completed by the end of 2020. But this, too, should be considered alongside c-Com's open platform concept. So in a later step, the data about wear that we have gained and optimised will flow into and supplement c-Com's process optimisation features. c-Com isn't just intended to smooth the path towards digital tool management, but also to improve the cutting process itself, so that users can make the most of an integrated, all-round solution. The new app is just as much part of c-Com as the blockchain solutions we are currently working on. In any case, we are well-prepared for connectivity in the production environment to become more intensified and see ourselves as a driver for that development. We've achieved a lot already – but we still have plenty in the pipeline. The digital potential is enormous.

Mr. Fiorucci, Dr Winkelmann – thank you for taking the time to talk to us. ■

Smart Mobile Tooling Solution

Wear detection

Clearance surface & crater wear

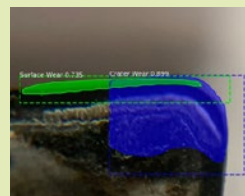

Macroscopic flaws & crater wear



Clearance surface wear & notch wear & macroscopic flaws

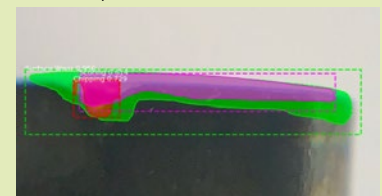

Insert breakage and clearance surface wear

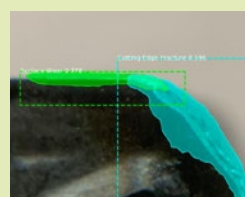

Clearance surface wear



Macroscopic flaws





HIGH PERFORMANCE² FOR THE AEROSPACE INDUSTRY

MAPAL and MAZAK are joining hands to exploit the full potential of machines and tools

No matter how powerful a machine is and no matter how high the machining values for which a tool is designed, it is only in coordinated interaction that they can make use of their full potential. The cooperation between MAZAK and MAPAL is an example of how the full potential can be exploited. →



From right: Hiroshi Itoh, Application Manager at MAZAK, and Koichi Matsuda, Director of MAPAL in Japan. MAPAL tools shown in the foreground with a MAZAK machine in the background.



From right: Naoya Ito, Team Leader; Akihiro Tsukuda, Coordinator (both from the MAZAK Manufacturing Process Solution Center); and MAPAL Application Engineer Markus Beerhalter in front of a MAZAK machine. Tsukuda and Beerhalter are both holding the part.

"To our customers, the machining time of parts is a top priority today," says MAZAK application manager Hiroshi Itoh. In order for manufacturing to be cost-effective, machining times have to become shorter and shorter. "We are seeing a need to reduce the costs for aluminium machining ever further in the aerospace industry in particular," says Itoh. Koichi Matsuda, managing director of MAPAL in Japan, confirms this observation: "Aside from precision and process reliability, the shortest possible machining times are always a major topic when we start working on projects with customers."

In an effort to offer customers the fastest and best solution possible, MAZAK and MAPAL have consolidated their skills in the field of machining

structural parts and worked on an example part. The HCR-5000S horizontal machining centre from MAZAK is used for this project. "The five-axis machine can reach spindle speeds of up to 30,000 revolutions per minute," says Hiroshi Itoh.

The aluminium part with original dimensions of 350 x 300 x 59 mm is machined with a total of six milling cutters from MAPAL's SPM program (structural part machining). "We use various types of milling cutters, for example cutters tipped with ISO indexable inserts, with brazed PCD cutting edges as well as solid carbide tools. This allows us to showcase our broad range of services," says Koichi Matsuda.

A DETAILED LOOK AT THE TOOLS, MACHINE DATA AND INDIVIDUAL MACHINING STEPS:

- 1** Roughing of the entire surface with the ISO shoulder milling cutter SPM-Rough with indexable inserts
50 mm diameter
- four inserts
 - cutting speed of 3,674 m/min
 - spindle speed of 23,400 rpm
 - a_e 27 mm
 - a_p 8 mm



- 2** Roughing of the inclined surfaces with the PCD-tipped OptiMill-Diamond-SPM
32 mm diameter
- three inserts
 - cutting speed of 2,813 m/min
 - spindle speed of 28,000 rpm
 - a_e 13,5 mm
 - a_p 8 mm

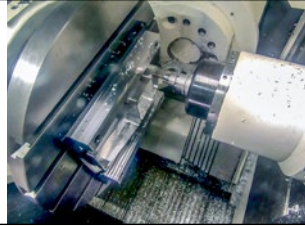

- 3** Roughing of the sides and one pocket with the OptiMill-SPM-Rough with innovative knurl geometry
25 mm diameter
- three inserts - cutting speed of 1,256 m/min (side), 745 m/min (pocket)
 - spindle speed of 16,000/9,490 rpm
 - a_e 8/25 mm
 - a_p 10 mm

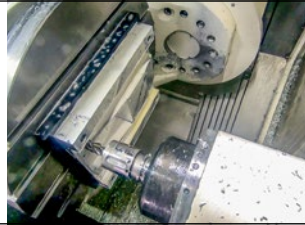

- 4** Finishing of the pocket walls with the OptiMill-SPM-Finish
12 mm diameter
- four inserts
 - cutting speed of 290 m/min
 - spindle speed of 7,710 rpm
 - a_e 0,4 mm
 - a_p 21 mm

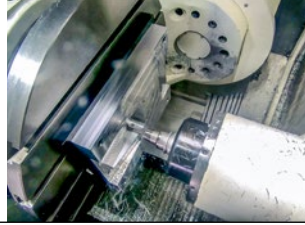

- 5** Roughing of the centre pocket with the OptiMill-SPM
16 mm diameter
- three inserts
 - cutting speed of 801 m/min
 - spindle speed of 15,950 rpm
 - a_e 7 mm
 - a_p 9 mm

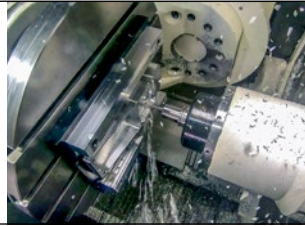

- 6** Roughing of the rounded pocket with the PCD-tipped OptiMill-Diamond-SPM
12 mm diameter
- three inserts
 - cutting speed of 764 m/min
 - spindle speed of 20,280 rpm
 - a_e 5,5 mm
 - a_p 6,5 mm

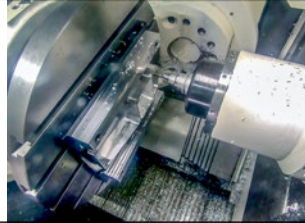

Together, MAZAK and MAPAL have determined the optimum tools and cutting parameters for the individual specific machining steps. Chucks from MAPAL will be used in addition to the tools. For example, MillChuck will be used for roughing with the OptiMill-SPM-Rough. The mechanical Mill-Chuck power chuck offers impressive clamping, easy handling and excellent radial run-out. The location bore is made with accuracy that goes right down to a matter of single-digit micrometres. A patented spring element in the connection ensures a defined tight fit between the tool and connection. The tool can reliably be clamped in the connection by hand without the aid of a torque wrench. In the case of high-performance milling machining as implemented with the sample part, the chuck displays all of its strengths. MAPAL also provided support with programming the optimum milling strategy.

Machining the sample part allows MAZAK to demonstrate the performance potential of its machine in practice and MAPAL to showcase its competence with regard to the tools and chucks. They got an opportunity to do so at the MAZAK open house event in Inabe, Japan, in May. Hiroshi Itoh emphasises: "When customers buy our machines, it is very important that we can also offer the optimum tools." ■

About MAZAK:

YAMAZAKI MAZAK is a family-run, privately owned company founded in 1919 that develops, produces and distributes CNC machine tools. MAZAK has ten manufacturing plants worldwide: five in Japan, two in China, and one each in the USA, Great Britain and Singapore.



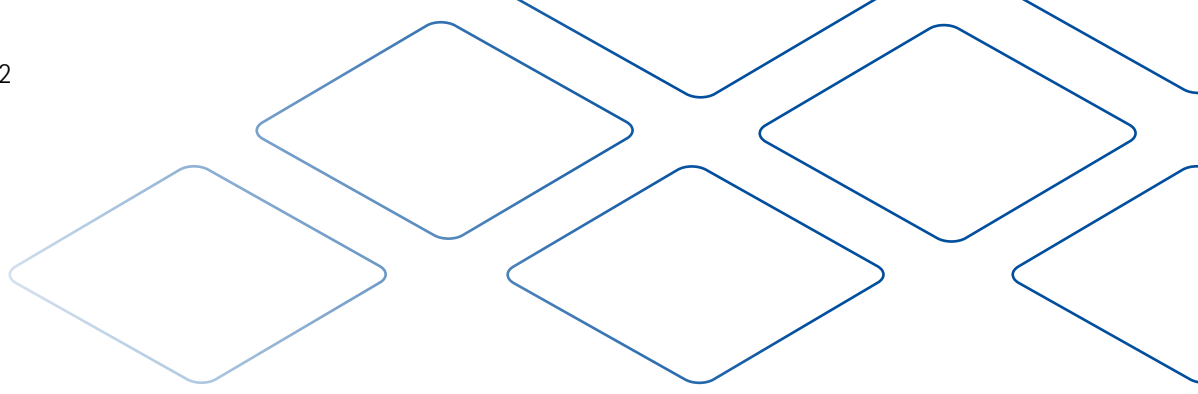

THE ROLE OF CLAMPING TECHNOLOGY BOTH NOW AND IN THE FUTURE

The connection between the tool and machine tool (the tool clamping system) is increasingly becoming an application-oriented, performance-enhancing element of the overall system. Although its fundamental role remains the same, i.e. chucks are still used to clamp tools, the application area and many other aspects of clamping technology are changing. Where previously clamping technology was merely a way of holding tools and mass-produced items, it now plays a decisive role in ensuring that both tools and machines reach their peak performance potential. In the future, it will even become the smart connection between the two.

For cutting, the clamping setup, tool, tool clamping technology and the machine tool itself need to be perfectly calibrated to each other and to the machining task required. As a solutions provider in the machining industry, MAPAL added chucks to its portfolio in the 1990s. That means today the company can today offer the entire machining process, including all tools and chucks.

Parallel to changes in the sector, MAPAL has also continually further developed its clamping technology. Its miniature hydraulic chucks are one example of this. Until now, limited manufacturing processes meant that the use of hydraulic clamping technology in micromanufacturing was only possible with reducer bushings – or not at all. However, miniaturisation is playing an increasingly large role in countless different sectors. Greater production capabilities and functionality need to be delivered in significantly less space. And space is a key factor. Space is limited – not just on board airplanes and in people's hands, pockets and bodies, but also in the production halls of companies.

These requirements have led to a demand for productivity that takes up as little space as possible. The cycle of miniaturisation has been applied throughout the entire supply chain. In terms of clamping technology, too, the machine and tool technologies of the micromanufacturing industry require ever more functions to be squeezed into a small amount of space.

THE CHALLENGES OF THE MICROMANUFACTURING INDUSTRY

For chipping thicknesses of just a few thousandths of a millimetre, the radial run-out accuracy of the chucks needs to be close to zero. Only at this level of accuracy is it possible to achieve both a long tool life and good surfaces at very high spindle speeds. On top of that, there needs to be a process-reliable way of ensuring that there is no chance of contamination by microparticles. A further important topic when it comes to machining in the micromanufacturing sector is applying the cooling lubricant. If too much lubricant is used, time and money need to be spent on cleaning the parts later on in the process – but quality and productivity suffer if there is insufficient or no cooling.

Add to that the requirement for simple handling processes and conventional manufacturing quickly reaches its limits. After all, the smaller the tools and chucks are, the easier they need to be to use. Every reduction in size makes interaction with external peripherals more awkward and difficult. With the use of shrink-fit or collet technology, significantly more time is required before the tools are ready to use. In addition to this, individual small deviations by components in multi-part systems can add up to significant errors.

In order to enable customers in the micromanufacturing sector to benefit from the advantages of hydraulic clamping technology (such as maximum ease of handling, highly accurate radial run-out, and precise clamping) and manufacture products quickly, easily, and with high precision, MAPAL has developed miniature hydraulic chucks. One example of these are MAPAL's hydraulic chucks with E25 hollow shank taper connections for the direct clamping of tools with a shank diameter of 3 mm. These chucks are made possible by the use of additive manufacturing – also known as 3D printing. Thanks to their innovative clamping chamber systems, internal force geometries, and optimally positioned coolant outlets, the MAPAL chucks meet all the challenges to the use of hydraulic chucks in micromanufacturing described above. They are used successfully in a wide range of different sectors – such as electrical, aerospace, and machine engineering, as well as medical technology, watchmaking, and robotics.

And micromanufacturing isn't the only sector benefiting from MAPAL's use of additive manufacturing. Tool manufacturers are now turning concepts that were previously unimaginable into a reality. Customers are now following the trend of using specialised solutions in their clamping technology too. →





HYDRAULIC CLAMPING TECHNOLOGY FOR EVERY APPLICATION

For example, to optimise the process the clamping point often needs to be moved closer to the actual working area on the part to achieve the best-possible result. To do this, users need chucks that have an extremely narrow design but don't skimp on performance. In these situations, thermal shrinking chucks are often used. However, hydraulic chucks are preferred due to the benefits previously mentioned. For this reason, MAPAL has developed hydraulic chucks with the narrow shape of shrinking chucks. These chucks can only be made by using additive manufacturing.

The chucks, which are individually constructed for the relevant application, offer financial benefits as well as advantages in terms of manufacturing technology. An example of this is: the dimensions of a part require the use of a tool with a long projection length. The customer has two options: they can use either a long chuck optimised for the application in combination with a standard tool, or a standard chuck and a long special tool. When the differences in tool life and chuck life are taken into account, the higher cost of purchasing a special chuck is amortised after replacing the tool just a few times.

PROCESS RELIABILITY – EVEN AT HIGH TEMPERATURES

In addition to its miniature chucks and chucks with extremely narrow contours, MAPAL is opening up a new field of application for chucks for its customers using 3D printing. This manufacturing method enables the hydraulic chucks to be used at temperatures of up to 170 °C. Previously, the temperature-sensitive brazed joints of the chucks (which are now no longer necessary) were a limiting factor. And that's more important than ever now that dry machining represents an increasingly large proportion of all manufacturing processes (in part for environmental reasons) – because dry machining involves very high temperatures. MAPAL has also developed solutions for machining that leads to thermal stresses beyond the 170 °C temperature limit. Cooling systems are integrated into the chucks with the help of additive manufacturing.

Friction stir welding is one example. In this process, a rotating tool is introduced into the material to be welded and then moved between the two aluminium workpieces to be joined. This leads to high temperatures that plasticise the material. When the material cools, this creates a solid, vacuum-sealed connection. The problem with this is that the heat generated by the process can travel through the tool and chuck into the machine spindle. There it can cause the chuck to expand and slide out of place. When the system cools, the spindle fixes the slipped clamping tool in place, which results in it no longer being able to be removed. If this happens, the resulting costs are enormous. In order to avoid this scenario, MAPAL has integrated a cooling circuit in the chuck using additive manufacturing. The internal air supply is provided through the spindle and can be adjusted very precisely. The entire system remains stable throughout the friction stir welding process.

MAPAL makes hydraulic chucks with the narrow profile of a thermal shrinking chuck for use in machining tasks with shape-based tool restrictions.

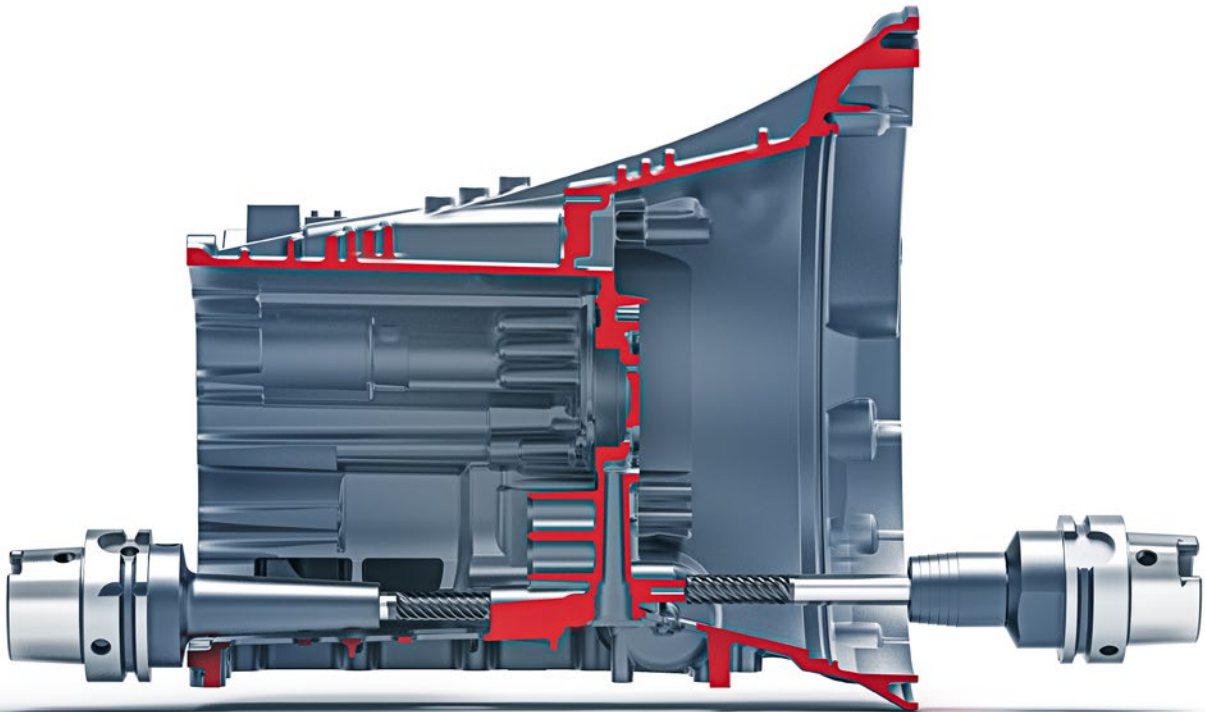

When carrying out machining with challenging shape requirements, customers today can choose between an application-specific chuck with a standard tool (left) or a standard chuck with a special tool (right).

DIGITALISED CLAMPING

MAPAL's customers already gain clear benefits from the clamping solutions achieved through new manufacturing processes. However, the role of clamping technology will become even more important in future. As the connection between the machine and the tool, smart clamping devices are able to provide important data about the machining. Particularly in mass-production processes, machinists are depending more and more on smart manufacturing systems that offer a high degree of automation.

A new approach is required for transmitting energy, data and media from the tool to the machine and vice versa. The relevant data can only be collected by the rotating system. This means that intelligent tools and sensors need to collect the data right at the point where cutting forces are being applied and where critical temperatures and vibrations may occur during machining. Direct data transfer is then needed so that the information gained can be used to influence the process in real time. That's why experts from industry, research and teaching have developed the HSK-i hollow shank taper, which operates as an intelligent connection. The HSK-i enables bidirectional energy and data transfer. In order to make this possible, the face surface of the hollow shank taper is equipped with eight electronic contacts. The system is currently in the prototype stage, and experts are working hard at the moment to ensure it's market-ready with the appropriate standardisation.

The added value this solution could provide to customers is undisputed. For example, the data fed directly from the working area can give machinists information about the forces acting on the tool. That then allows them to draw conclusions about the remaining tool life. That means the customer is able to obtain a longer tool life from their tools – or, conversely, ensure that they are replaced before a breakage occurs which could potentially cause damages to the part being machined. On top of that, relevant data makes it possible to determine available capacities more accurately and enhance digital services for customers.

DIFFERENCES COMPARED TO WIRELESS DATA TRANSMISSION

In the past, it has been possible to transmit data from the working area – but only using wireless data transmission. The devices in question were provided with power by batteries. As a result, they required a significant amount of maintenance and could not be used efficiently on many cutting machines. It is only thanks to the HSK-i's ability to transmit data directly from the working area to the machine controls that data transmission is possible easily, quickly, and without intensive maintenance requirements. On top of that, the possibilities provided by connectivity are what make sensor solutions interesting for machine operators today. Previously, evaluating any data collected required a large amount of effort that was disproportionate to the benefits it provided. Today, assistant systems are able to carry out these tasks. What's more, machines are significantly more adaptive and are able to respond to the data accordingly.

The fields of connectivity and digitalised clamping still offer huge potential. And so MAPAL's work continues: firstly to find new solutions that enable customers to implement hydraulic clamping technology even more efficiently or in new areas, and secondly to develop intelligent systems that make data collection and transmission easier – or possible in the first place. ■



The chuck used for friction stir welding has its own cooling circuit.

Long tool lives, low noise development,
and the best-possible machining results

GETTING VIBRATIONS DURING MILLING TASKS UNDER CONTROL

In many milling tasks, vibrations occur as a result of a range of factors – such as the clamping setup or the machining parameters. This can lead to chatter marks on the surface of the part, short tool lives, and spindle bearings that wear down quickly as a result of the heavy demands placed on them. Strong, unacceptable vibrations occurred during two machining tasks carried out by the Schweizer Group in Plauen. The company turned to MAPAL for help in resolving the issue. →

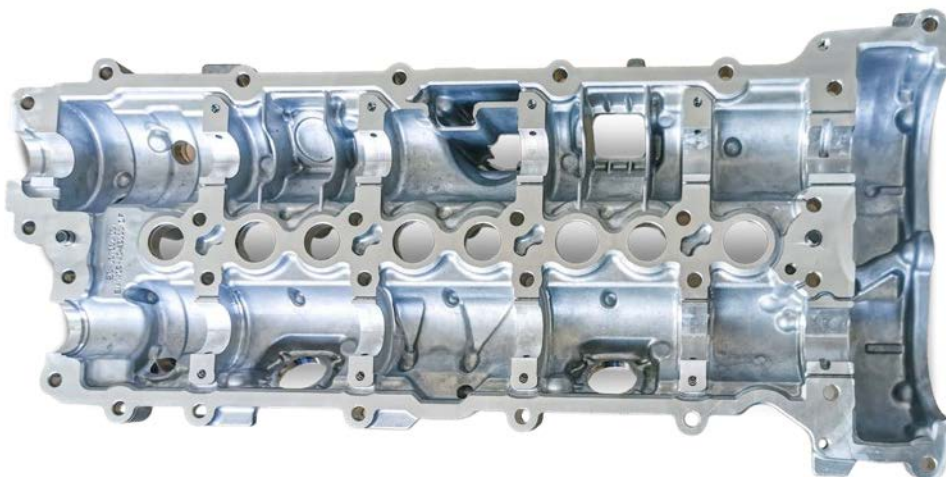

*Left image:
Typical workpiece: View of the
interior of a cylinder head cover
showing both camshaft bearing
grooves*

*Right image:
Full view of the extremely long and
narrow milling cutter for the
machining of cylinder head covers*



Andreas Wittenauer (left) and Dirk Steinbach are visibly pleased with the successful tool solution for the machining of a cylinder head cover.





- 1 Fully automated production line for the machining of die-cast aluminium parts for the automobile industry.
- 2 The milling head is tipped with indexable PCD inserts on both the front and back end and is able to machine the side walls of the bearing blocks.
- 3 While their bearing surface is merely prepared for further machining, the side surfaces of the bearing blocks need to be machined with high accuracy.
- 4 The pocket is deep within the bell-shaped housing of the filter.

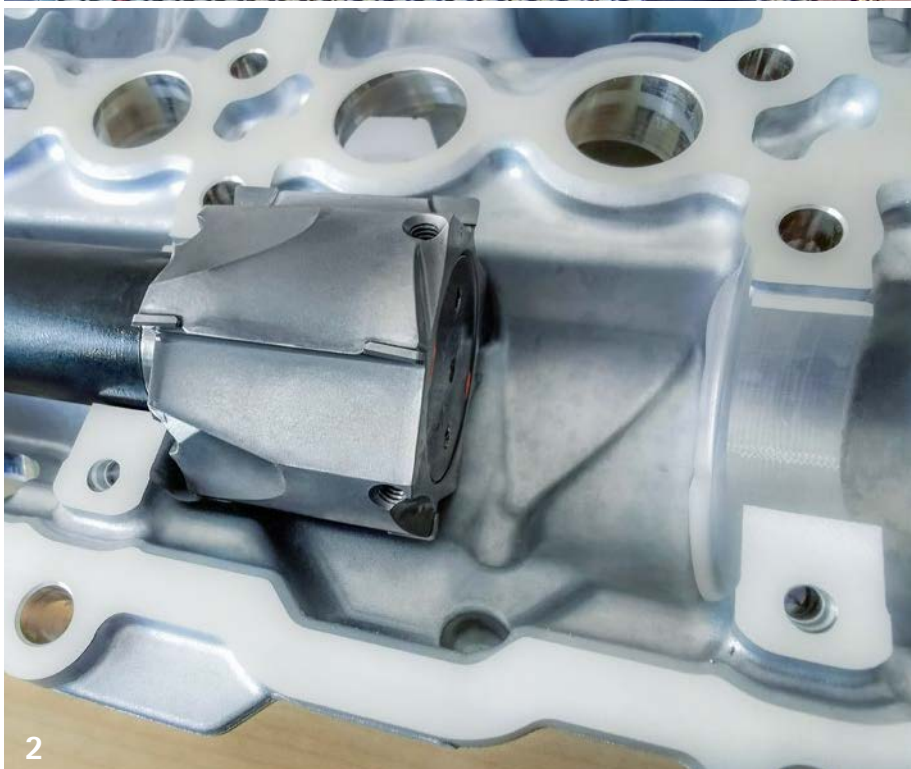

"We machine die-cast parts made by the group's foundries," explains Dirk Steinbach, Technical Leader at the factory in Plauen run by Schweizer Group Global GmbH (SGG). SGG is a globally active company with around 650 employees at six locations, including sites in China and the Czech Republic. The group primarily supplies car manufacturers and specialises in power train elements and electronics. Typical parts produced by the group include ready-to-install machined aluminium and magnesium components for engines, transmissions, power trains and ancillary units, along with housings for vehicle electronics and infotainment systems.

MAXIMUM COST-EFFECTIVENESS IS ESSENTIAL

"Our 160 employees primarily manufacture high-volume series of up to 1,000,000 parts. In addition to meeting strict accuracy requirements, it is imperative that the machining is highly cost-effective", says Dirk Steinbach. He explains that every tenth of a second counts and any unnecessary steps in the working process need to be avoided. For that reason, the manufacturing process is highly automated and is carried out by machines that are linked together as islands or lines by handling and testing facilities. Due to the high demands of the cycle times, SGG uses specially laid out combination tools that are precisely adapted to the relevant requirements. This in turn requires the development of corresponding tools and processes with the help of the tool provider. That's why SGG has been working closely with MAPAL for many years. The expertise of the tool manufacturer's employees was most recently called for in two particularly challenging cases.

EXTREME VIBRATIONS ON A CIRCULAR MILLING CUTTER

"In the first case, a lateral pocket needed to be milled deep within the housing of a fuel filter", says Andreas Wittenauer, Head of Application Technology for PCD Tools at MAPAL. A circular milling cutter with a length of about 185 mm and a shank diameter of 29 mm was used to do this. The milling head itself has a maximum diameter of 48 mm. After entering the bell-shaped workpiece, it mills a pocket with a depth of about 10 mm in the side of the housing wall. This creates a link to the blind bore of a connection nozzle positioned laterally at a sharp angle, allowing fuel to enter the filter. As a result of the one-sided machining, the tool developed vibrations so extreme that the permissible g-forces were exceeded. Even when SGG went as far as dividing

this machining process into separate steps, the vibrations remained very strong and the machining process was very loud. "The machining could even be heard in the adjoining hall", says Dirk Steinbach. And that doesn't even take into account the long machining time. In addition to this, the strong vibrations had a negative effect on the tool lives and the spindles.

VIBRATION DAMPING THROUGH DYNAMIC IMBALANCE COMPENSATION

"In order to minimise the vibrations, we provided the milling cutter with a vibration-dampening shaft. It is equipped with an auxiliary mass made of a heavy metal that can move both axially and radially", reveals Andreas Wittenauer. The system is based on the principle of dynamic unbalance correction. The auxiliary mass evens out the vibrations by moving in the opposing direction. Steel spring assemblies then ensure that the auxiliary mass returns to its resting position. The internal vibrations that occur are dampened by an oil filling. "In addition to this, we angled the brazed PCD cutting edges by 30 degrees", adds Wittenauer. This enables soft cutting and minimises the noise produced.

A VIBRATION-PRONE COMBINATION

"The second situation was an even bigger challenge", says Andreas Wittenauer. SGG uses a long, narrow milling tool to machine the bearing blocks in the cylinder head cover of a supercar. The actual bearing surface of the camshaft is only pre-machined in Plauen; the car manufacturer completes the fine machining themselves. The side surfaces of the bearing bracket, on the other hand, are fine-machined by SGG. The manufacturing is subject to high precision requirements as the engine has a valve lifting system. Adjusting the camshaft in this way enables the engine to run at a lower fuel consumption and with only a few vibrations.

The original intention was to use a 300 mm milling tool to machine the bearing blocks. The tool's completely solid head has a diameter of 48.4 mm, is 38 mm long and is positioned on a shank with a diameter of just 26 mm. In addition to this already vibration-prone combination, the cast part has a large surface and extremely thin walls, making it a near-perfect sounding board for vibrations. These vibrations were even further exacerbated by interrupted cutting during the machining process. Taken altogether, the vibrations were so strong that they resulted in chatter marks and even tool breakages.

REFINED SOLUTION FOR TOP-QUALITY SURFACES AND A LONG TOOL LIFE

"In order to get these vibrations under control, we developed a two-step solution with different measures for the shank and the milling head", explains Andreas Wittenauer. The combination of the long, narrow shank and solid milling head has the potential to result in the development of complex vibration patterns. In order to compensate for this, specially adjusted countermeasures must be taken for each area separately. Here, too, the tool experts worked with the principle of dynamic unbalance correction. They placed a large number of small, highly dense and freely movable auxiliary masses in the shank of the milling cutter. These counteract any vibrations that occur by rearranging themselves depending on the tool's vibration state at any given time. However, a different solution needed to be found for the milling head itself, which has a tip made of PCD cutting edges. As the blade geometry might need to be adjusted in order to keep the required maintenance as low as possible, the milling head needed to be replaceable. To enable this, MAPAL's experts developed a vibration damping system with a single auxiliary mass capable of moving both radially and axially and made of a high-density metal alloy. In order to minimise the swinging of the milling head, the mass always takes up an opposite balancing position.

With this tool solution, the vibrations were reduced to a minimum. Chatter marks on the workpiece are now a thing of the past. In addition to this, the machine spindle is preserved and the tool life of the PCD cutting edges is significantly increased.

AN IMPRESSIVE SUCCESS

"Both of MAPAL's tool concepts meet our requirements and have more than proven themselves in practice", confirms Dirk Steinbach. In the first case, using the new circular milling cutter reduced the cycle time for the workpiece series by up to 14 seconds. And the tools meet the tool life required in both cases. "In the case of the circular milling cutter, there's an audible difference. The sound level during machining has dropped to less than 78 dB", Dirk Steinbach points out. He adds that this represents a substantial contribution to improving working conditions. ■



JAGUAR



RANGE
ROVER

MAPAL IS PART OF PROJECT PERSEUS

Project Perseus: Turning Internal Combustion Engine Manufacturing Facilities into Equipment for Electric Drive Unit Production

The Advanced Propulsion Centre (APC) recently granted funding to the Perseus project, which will explore how Jaguar Land Rover's traditional UK based internal combustion engine (ICE) manufacturing facilities can be adapted to make electric drive units (EDU) for hybrid and electric vehicles, alongside diesel and petrol engines. This project will support Jaguar Land Rover's commitment to offer customers electrified options for all new Jaguar and Land Rover models from 2020. The 27-month project, which commenced in April 2019, is led by Jaguar Land Rover and brings together an expert consortium from the Manufacturing Technology Centre, Mapal, JW Froehlich, Fives Landis, Horizon Instruments, Birmingham City University and HSSMI, who will additionally provide project management and coordination support for the project overall.

Throughout the lifetime of the project, partners will work to ensure that Jaguar Land Rover's state-of-the-art manufacturing machinery, systems and processes are designed to be flexible

enough to manufacture both ICE and EDUs efficiently, within the same production facility. For all partners, Perseus will build on existing manufacturing capability, producing know-how and case study evidence in the conversion of existing ICE manufacturing capacity for EDU manufacture.

The project will ensure that existing UK engine manufacturing facilities, such as Jaguar Land Rover's Engine Manufacturing Centre near Wolverhampton, can be further developed for the transition to electric vehicles and at a global level, aims to support the UK to become a major centre for the electric vehicle industry.

Richard Lancaster, Advanced Manufacturing Technology and Strategy Manager, Jaguar Land Rover, explained the potential of the project further: "Perseus is aligned to Jaguar Land Rover's vision of Destination Zero to help shape future mobility: zero emissions, zero accidents and zero congestion. Our ambition is to make societies safer and healthier, and the environment cleaner.

Perseus provides the opportunity to develop effective and efficient methods and processes that will enable our plant to offer full flexibility between electric units and our clean, refined and efficient petrol and diesel engines. The project will help give us the speed and responsiveness to produce what our customers want at the right time, as we transition to an electrified future."

Dr Axel Bindel, Executive Director, HSSMI, added: "Flexibility of current and future assets is key to reduce risk in the changing market, given the uncertainties of growth. As HSSMI we are excited to be part of this important project to offer our expertise in advanced simulation and manufacture of electric drive units. Upscaling of manufacturing capacity has to go hand in hand with the increase of production flexibility. The support by the APC enables us to use this project to build relevant new capabilities for the manufacturing sector." ■

» With our continuous relationship with JLR, MAPAL are delighted to join a consortium of partners into the next generation of electrical powertrain. We will bring our experience and core competence to support areas to the benefit of all parties involved. «

Wayne Whitehouse, Managing Director MAPAL Ltd.



LOWERING COSTS WITH SOPHISTICATED TOOL SOLUTIONS

MAPAL tools demonstrate their streamlining potential throughout their entire service life





At less than ten percent of the total operating costs, the cost of procuring tools in cutting manufacturing might not initially appear to be a significant lever in rationalisation measures. Nevertheless, it is worth analysing the influence of tools and optimising both their immediate costs and costs that are indirectly affected by them throughout the entire manufacturing process. MAPAL has consciously chosen an approach that takes the total costs into account: "Tool-related costs have a significant impact on the overall costs", points out Siegfried Wendel, Senior Vice President of Global Sales at MAPAL. "For this reason, it is worth focusing less on the simple purchasing costs of individual components, and more on the costs of the process time, when choosing a tool concept. And, as well as this, on the impact of the tools on the overall costs. So our products aren't optimised for the cheapest sales price, but to continue delivering benefits throughout their entire service lives."

How do tools impact overall operating costs?

Precision tools influence overall operating costs in various ways. First, and most obviously, there are the costs of the tool itself: the costs of purchasing and using the tools, including the cost of non-productive time – for example, when a tool needs to be replaced. But on top of this, cleverly designed tools have an impact on investment costs. For example, a customer might be able to avoid buying a new machine if suitable tools allow the machining to be carried out on their existing machines. Similarly, increased machine productivity reduces the number of machines that need to be purchased. It might even be possible to replace a special machining process by using the right tool. Process reliability is another factor on which tools can have a significant impact – for example, by avoiding the need for measuring tasks. And finally, gains can be made on rationalisation and cost-reduction when it comes to services, particularly in logistics, storage, and employee training.

Annual savings of 83,000 euros with a combination tool

Combination tools are the classical example for a direct reduction in operating costs. This is demonstrated in the following example from the car industry: A transmission housing made of the cast aluminium alloy AlSi9Cu3 was machined on a standard machining centre with a hollow shank taper connection. More specifically, the process involved the drilling of recesses in the variable valve timing (VVT) system. The most important concern was the accuracy of the large diameter during cutting. The shape is pre-cast, requiring a stock removal of 2 – 4 mm. There is no pre-machining. In terms of tool design, the customer's aims were

- to carry out the machining with as few tools as possible;
- to increase productivity by combining tools;
- to simultaneously maintain maximum weight and moment-of-tilt requirements.

Due to its thin walls, the part was prone to vibration during machining. In combination with extreme length-to-diameter proportions, complicated shape characteristics, necessary control cuts, and tolerances in the IT6 range, the machining process placed high demands on the tool technology.

In contrast to the competition, MAPAL was able to achieve the machining with just one combination tool. With the tool's lightweight construction, the weight and moment-of-tilt requirements are not a problem. The cycle time is also reduced; the annual production time saved amounts to a total of 833 hours. Based on machine operating costs of 100 euros per hour, the operator saves over 83,000 euros annually.

Higher machine utilisation, reduced tool costs, greater process reliability

The machining of the tube sheets for shell and tube heat exchangers demonstrates how tool design can have an impact on process reliability costs. The tube sheet forms the end of the bun-

dle of tubes in the heat exchanger. Depending on the size of the heat exchanger, it may have a large number of bores – often as many as several hundred. In order to ensure that the fluid medium does not escape at the point of connection between these parts, the bores have high positional and dimensional accuracy requirements. Because of the tolerance requirements and the cost of solid drilling operations, the choice of tool has an especially high impact here.

MAPAL's three-bladed TTD-Tritan replaceable head drill demonstrates its full potential in this application. Due to its limited use of cost-intensive solid carbide, the replaceable head system represents resource efficiency and reduced inventory costs. At the same time, it achieves the performance level of a solid carbide drill. For this application, every machining diameter is required at multiple lengths. In this case, the separate provisioning of drill heads and tool holders has a further positive impact on inventory costs.

For example, the TTD-Tritan achieves significant improvements compared to the previously used double-edged tool from a competitor when machining tube sheets made of SA-516-70N high-carbon steel with a diameter of 25.6 mm and a bore length of 63.5 mm. The replaceable head drill reduces machining time by 57 percent: the MAPAL tool needs only 29 minutes to complete 550 bores. These benefits are a result of the TTD-Tritan's 59 percent higher feed rate on the one hand and an improvement of the process on the other: users no longer need to pilot or subsequently clean the part. In addition to this, the TTD-Tritan improves the direct machining costs, as the three-bladed replaceable head drill has a 90 percent longer tool life than the competing tool.

Overall operating costs reduced by eliminating a setting process

The main fields of application for tools with guide pads are reaming and fine boring applications with extremely high shape and position tolerance requirements. The advantage of these tools is that diameter and back taper of the

precision blades can be set with micrometre-accuracy. However, the necessity of setting the diameter and back taper of the blades is also a disadvantage. These setting processes take time and expertise on the part of the operator. MAPAL has developed the EasyAdjust system to take this additional effort into account. A high-precision adjustment system with a cassette and pre-set back taper replaces one of the two setting processes. Accuracy is retained and handling is simplified.

Take, for example, the application of an external reamer with an internal diameter of 75 mm equipped with the EasyAdjust system. In this case, the reamer machines pins on planetary carriers made of heat-treated steel. At a diameter of 75 mm, the pins have a tolerance of 18 μm . The maximum permissible deviation of the cylindrical form is just 5 μm . The potential of the EasyAdjust system is particularly apparent in the case of external reamers. The adjustment controls on external reamers are difficult to access, making the setting process even harder. As a result, not having to complete the back taper adjustment makes a big difference. The high accuracy combined with an economical, four-bladed TEC indexable insert ensures the maximum cost-effectiveness of the machining: The external reamer operates on a machining centre at a cutting speed of 120 m/min and a feed rate of 60 mm/min. In this scenario, one cutting edge can machine 470 pins. A new indexable insert is only required after 1,880 pins. →

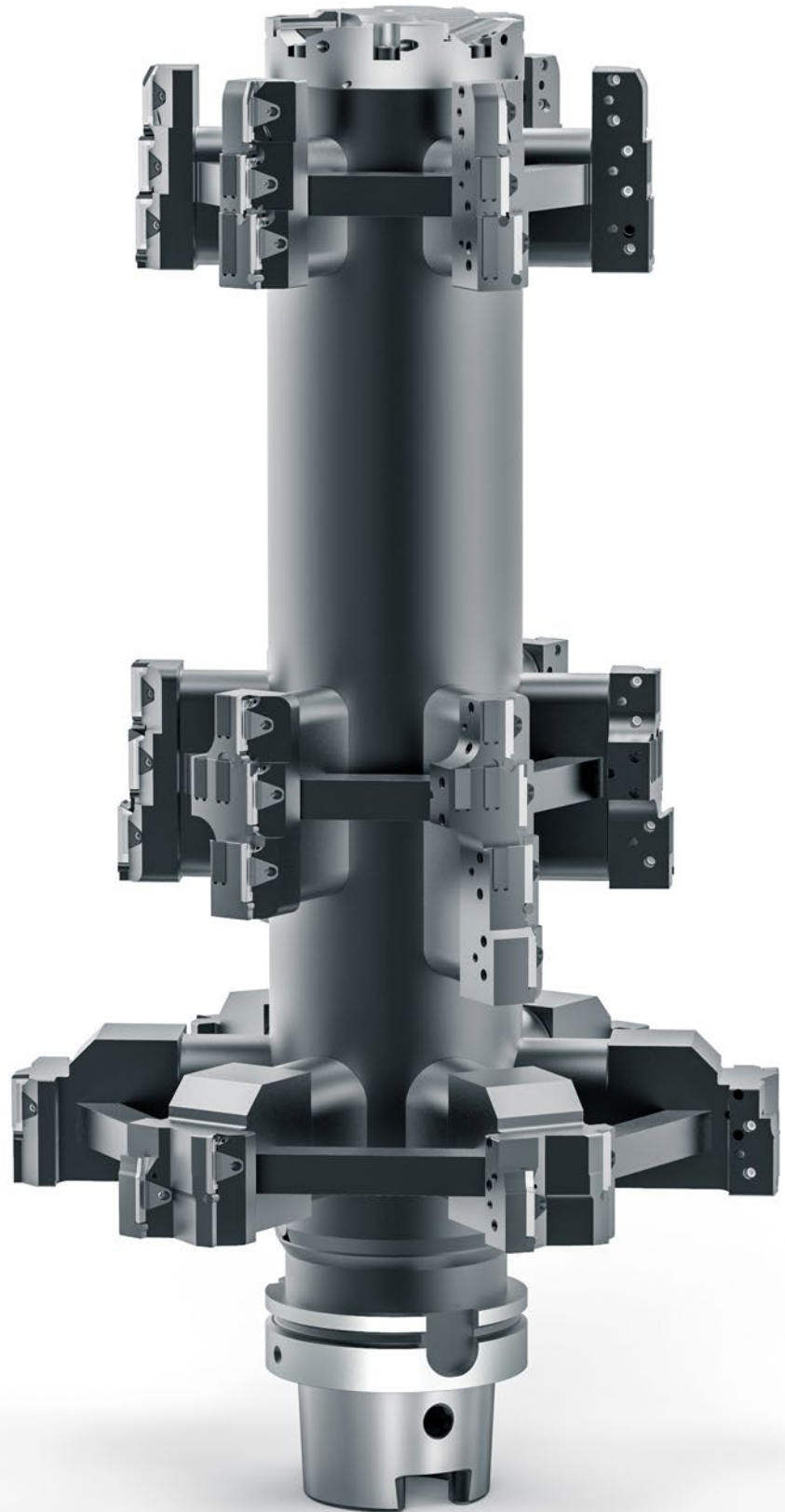

MAPAL's lightweight combination tool process-reliably meets all requirements and saves 833 hours of machining time every year in comparison with the competing tool.



Less than half the machining time and a 90 percent longer tool life: The TTD-Tritan replaceable head drill significantly increases cost-effectiveness in the machining of tube sheets for heat exchangers.



MAPAL's EasyAdjust system reduces the setting times for high-precision reaming tools. The back taper is integrated in a cassette, meaning that no manual adjustment is necessary.

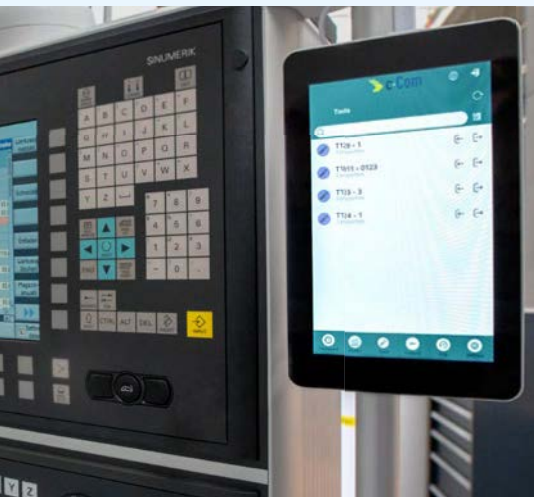

With c-Connect, the open-cloud platform c-Com offers a simple and cost-effective way of networking machines. Operators benefit from cost-saving results immediately.



"When choosing a tool concept, the purchase costs are less important than the total tool-related costs across the entire process time." Siegfried Wendel, Senior Vice President for Global Sales at MAPAL.

Digital services reduce overall operating costs through reliability during production

By now, the advantages of digital connectivity are well-known. In cutting manufacturing, too, digital possibilities have become an indispensable driving force in the overall operating costs. Nevertheless, the investment and start-up costs of digital services are often a hurdle for companies that carry out machining. Ultimately, their implementation in existing manufacturing processes often involves factors such as the need to modernise the available machinery or carry out new installations.

With c-Connect, the open-cloud platform c-Com offers a simple and economical way of networking machines. c-Connect makes it possible to digitally transfer tool measurement data from the setting fixture to the machine, registers inventory changes, and is able to monitor the machine status via various sensors and the c-Connect box. Simply, compatibly, and quickly. Operators benefit from cost-saving results immediately. Here are just some of the benefits:

- no chance of errors resulting from the manual inputting of tool data;
- information concerning the tools, such as their tool life, remains available after the tools have been removed;
- transparent data is available to all persons involved;
- machine downtimes are minimised.

Small decisions with a big impact

MAPAL's tool specialists are continuously developing product and process solutions with the aim of achieving maximum cost-effectiveness for their customers. With 70 years of experience, a broad range of products, and a global presence, the precision tools manufacturer offers customers future-proof and technologically leading solutions: "When looking at the overall costs, there are a lot of ways in which our tools can make a difference. For that reason, our technical advisors always design the tools specifically for each individual customer – and offer a service warranty that we are able to fulfil optimally through our global service network", emphasises Siegfried Wendel. "With the right technological partner at your side, completely new opportunities for cost savings become available." ■

NC theme day in Lindlar: Programming, simulating, milling



In February, voha-tosec in Lindlar (MAPAL's Centre of Competence for the Die & Mould sector) was the site of a theme day devoted to NC milling applications. The event was organised by the Osnabrück software manufacturer CCE Systems Engineering. Together with MAPAL's experts from Aalen and Lindlar and the measuring technology specialists HEIDENHAIN from Traunreut, they demonstrated ways of increasing productivity in milling tasks.

Even an apparently perfect machining process can be optimised. But how? The NC theme day aimed to answer that question. CEE Systems Engineering hosted the event in cooperation with voha-tosec. Experts from both companies systematically presented the individual steps of a milling task in order to demonstrate the potential for optimisation. It quickly became apparent that programming, simulating, and milling involve highly complex subject matter that requires significant specialist knowledge to understand. Many opportunities for increasing milling productivity remain untapped as they are largely or completely unknown. The speakers at the theme day shed light on the topic.

First of all, Jens Ortmann and Thorsten Scheibner of CCE Systems Engineering gave the 30 invited industry professionals in attendance an insight

into new simulation and software solutions. Modern, digital tools not only save users time in a milling process – they also make it possible to easily identify the cause of errors.

Thorsten Bothe of voha-tosec discussed roughing and finishing. The product specialist highlighted the economic impacts of modern tool geometries. Application consultant Wolfgang Dufter of HEIDENHAIN illuminated the field of measuring and controlling.

Finally, consideration was given to the topic of tool-setting areas – because there are interesting new digital developments that apply to machining processes upstream and downstream of the main machining task as well. These insights were provided by Alexander Schuh, product specialist at MAPAL.

In-between the information sessions, there were live demonstrations of the tools that were being discussed. The experts demonstrated special procedures, such as trochoidal and helix milling and using shoulder radius milling cutters for finishing, as well as the quick commissioning of parts. On top of that, there was an opportunity to visit the Centre of Competence and time for guests to have individual in-person discussions. "The day was a complete success for everyone involved, and I'm sure it won't be the last event of this kind in Lindlar", says of voha-tosec's director Carsten Klein confidently. "We are working to host more theme days with or by partners at voha-tosec." ■

MAPAL precision tools for the Netherlands:

LAAGLAND – the machining specialists

In addition to its headquarters in Aalen, MAPAL is represented by offices in all of the world's important markets. A global network of capable service and distribution partners enhances the local consulting and support offered to customers. In over 25 countries. In the coming editions of IMPULSE, we'll be continuing a new series that shines a spotlight on MAPAL's partners. First up is LAAGLAND in the Netherlands. The IMPULSE team spoke to Eddo Cammeraat, the director and co-owner of the business. LAAGLAND sells both tools and machines. The company's headquarters is located in Capelle aan den IJssel near Rotterdam.

PROFILE: Eddo Cammeraat

Eddo Cammeraat has led the business since 2001. Prior to that, the industrial and mechanical engineer worked for Siemens in Den Haag for many years, where he gained extensive experience in distribution and engineering.

Cammeraat and Edwin van der Spek became the co-owners of LAAGLAND after a management buy-out in 2006.



Picture source: Laagland

Mr. Cammeraat, production for many companies in Germany is currently limited or non-existent due to the coronavirus pandemic.

How are things in the Netherlands?

It's important to take the situation seriously – everyone is aware of that. The Dutch government has taken measures to limit the spread of the epidemic. Nevertheless, many companies remain open and are still manufacturing their products. There is a high demand for certain products. Less so in the automobile or aerospace industries, but far more when it comes to medical technology and general machine engineering. Production in those fields remains steady, though at a slightly lower level in machine engineering.

LAAGLAND has 20 employees. How are you handling operational processes under these exceptional circumstances?

We are using all available means to keep our team safe. The majority of our employees, particularly those in the field, are currently working from home. Our office is operating on a skeleton staff that takes care of our commercial coordination. And we're keeping in touch with our customers by phone and via videoconferencing. If customers allow it, we also visit them on site. When that happens, we make sure to maintain the necessary distance and sometimes move meetings outside.



Picture source: Pixabay

I understand your company has had to overcome other challenges in the past.

That's right. You could say that LAAGLAND is a bit of a "grande dame" at this point. We have a history stretching back to 1931, starting with the industrialist Henry Sonnenberg. Sonnenberg founded a machine tool factory in Düsseldorf in 1919. In 1933, he decided to move the factory to Rotterdam. LAAGLAND became the "workshop" of the company. Sonnenberg's company eventually became the Hunter Douglas Group, which LAAGLAND was also a part of. In the mid-1990s, LAAGLAND was sold to investors. LAAGLAND had to refocus itself and developed into an independent trading company for machines and tools. After

How is LAAGLAND currently structured, and who are your main customers?

We primarily supply the components industry. There are a lot of small companies in the Netherlands that operate in the aerospace, automobile, medical technology, IT, and machine engineering industries. For that reason, we have very strongly focused on complex machining tasks over the past years and now offer our customers complete solutions. In addition to MAPAL's range, we also sell CNC metal-cutting machines, clamping systems and devices for the measurement, setting, and the dispensing of tools. Services such as the commissioning and maintenance of machines, as well as the reconditioning of tools, are of course also included.

When did you start working with MAPAL, and what makes them different?

MAPAL and LAAGLAND have been working together for decades. The relationship was already in place when I started working for LAAGLAND 19 years ago. Over the years, close and personal contacts have developed between the two companies. For me, the most important characteristic is the relationship of trust that we maintain. LAAGLAND's employees and I are in constant contact with MAPAL's office sales staff, we speak frequently to their experts in the Centres of Competence, and we also receive a lot of support from the sales office in Cologne, which deals with the Netherlands. The current team led by Hans Jürgen Koeber is an important partner for us, particularly when it comes to meeting the needs of large customers in the Netherlands. →

What MAPAL products are in highest demand among Dutch customers?

In case you didn't already know, the Netherlands is a hub for machine engineering. We make many different types of machines, from simple packaging machines to large farming machines for the agricultural sector. The parts that are manufactured for this are typically produced in small batches or as single items. But they are still complicated workpieces made of difficult substances, such as titanium or composite materials. Machining these parts requires complex and highly accurate tools.

MAPAL's products are designed precisely for these kinds of applications. We have by now attained a very good market position and built up a strong reputation as an experienced partner of the metalworking industry. Our customers can rely on us supplying them with the right tool for every application.

Last but not least, tell us what's in store for LAAGLAND in the future.

Of course, we hope that the coronavirus pandemic will be overcome in the near future and that the economy will recover swiftly. LAAGLAND will continue on its path as a specialist for complex machining solutions. However, we will also turn our attention towards new sectors and concentrate more on extending the range of our services. That means we will be focusing our efforts on the market for standard tools with greater intensity than previously. We can already see that demand in this sector is increasing. The industry is driving automation forward – there is a need for tools to be quickly available. I think we still have a lot of opportunities to grow with MAPAL ahead of us. ■



LAAGLAND
MACHINES TOOLS & SERVICE

LAAGLAND B.V. in Capelle aan den IJssel /
The Netherlands

Tel.: +31 10 292 22 22

Fax: +31 10 292 22 29

Email: informatie@laagland.nl



LAAGLAND is a long-time distribution partner of MAPAL's. The company's headquarters is in Capelle aan den IJssel near Rotterdam.



Additional representation in Belgium

The distribution company Optimax BVBA has been an official MAPAL representative since 1st January 2020. The company acted in this capacity for the first time at the MNE (Machinery Network Event) trade fair in Kortrijk, Belgium. Optimax is now able to supply the complete MAPAL range to its customers in the automotive, rail, and machine and plant manufacturing industries, as well as those in the die and mould sector.

A number of MAPAL's subsidiaries have been working with Optimax since 2008. This relationship has developed into a trusted partnership, leading to the decision to make Optimax the official MAPAL representative for Belgium.

Optimax was founded by Philippe Wils in 1998. "Providing maximum support to our customers during the optimisation of their manufacturing processes is part of our company's philosophy. We offer them the appropriate tool solution for every application", says Wils. The company's range of products and services has expanded significantly as a result of distributing MAPAL's complete range. Optimax is based in Schilde near Antwerp. Wils is a mechanical engineer with extensive technical expertise and knowledge of the sector. He leads a team of five employees. ■



OPTIMAX
 HogeHaar 25
 2970 Schilde
 Tel.: +32 (0) 3 3853897
 Email: info@optimax.tools
www.optimax.tools

MAPAL SPOTLIGHT



DESIGN
AWARD
2020

Design prize for MAPAL clamping tools

MAPAL's clamping tools meet all the hallmarks of good industrial and product design. What's more, they have now been recognised with one of the world's most respected design prizes: the iF DESIGN AWARD. It is the oldest independent design award and has been presented in recognition of exceptional achievements in product design since 1953. The design competition is organised by the Hannover-based iF Industrie Forum Design association.

In January, an independent jury of experts evaluated approximately 7,300 submissions from 56 countries. MAPAL's clamping tools were among the winners.

The design agency Ottenwälder & Ottenwälder from Schwäbisch Gmünd developed the new design concept alongside MAPAL's product managers. Their aim

was to give the entire range of clamping tools a unified appearance. Designers followed the stipulation to achieve maximum stability with an optimal use of resources.

MAPAL's new clamping tools are characterised by flowing, bionic shapes and polished surfaces. New control elements and characteristic features impart a distinctive corporate design. The new look not only improves the appearance and recognisability of the products. The clamping tools also satisfy environmental and economical requirements, as they feature increased corrosion resistance and can be manufactured using fewer resources. ■



